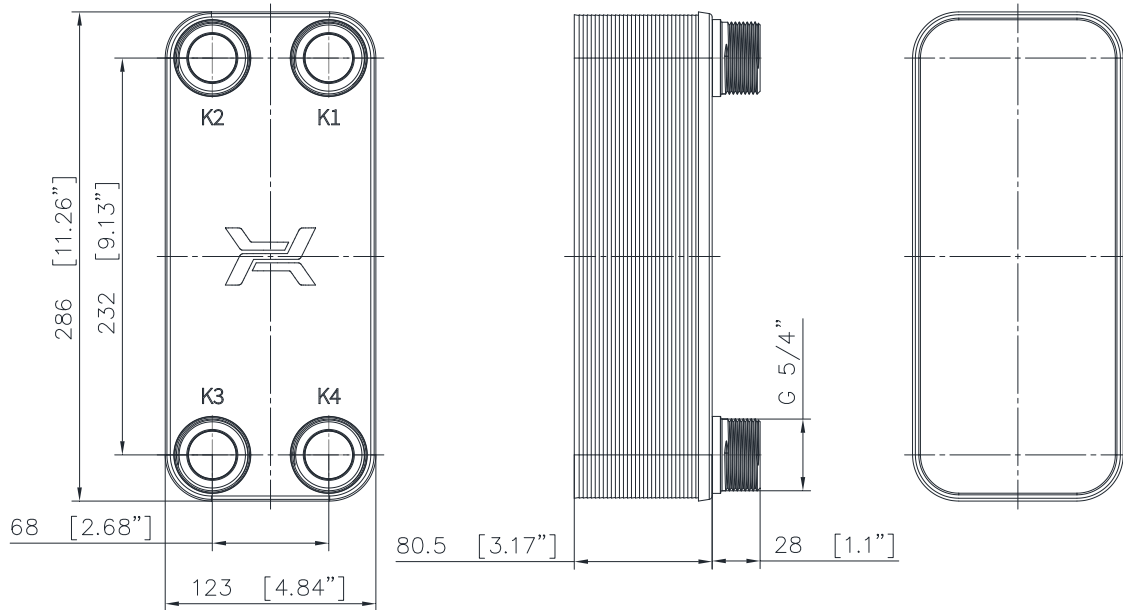

HEX type

LB31-30H-5/4"

Catalog Number

0203-0684

WORKING CONDITIONS

	Side 1	Side 2	
Max pressure	30	30	bar
Max temperature	230	230	°C
Min temperature	-195	-195	°C
Fluid group	1	1	

CONNECTION TYPES

K1	External thread G 1 1/4"
K2	External thread G 1 1/4"
K3	External thread G 1 1/4"
K4	External thread G 1 1/4"

DESIGN DATA

Side 1 volume	0.9 l
Side 2 volume	0.9 l
Weight	5.2 kg

CONNECTIONS LOCATION
(Counter Flow)

K1 - side 1 inlet
K2 - side 2 outlet
K3 - side 2 inlet
K4 - side 1 outlet