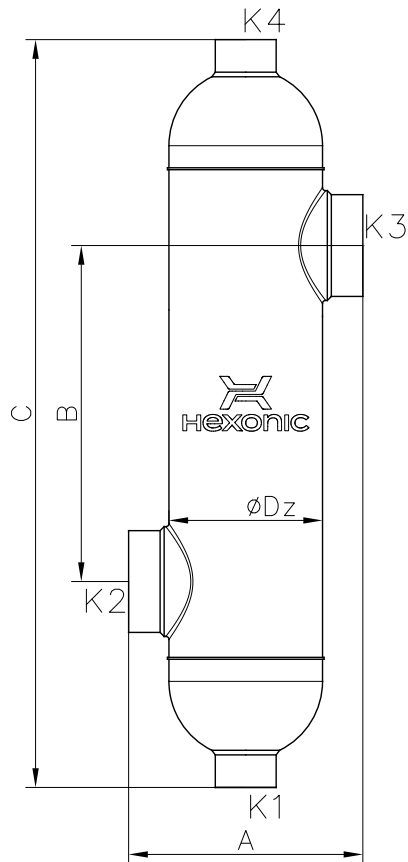

HEX type

B70

Catalog Number

0170-0002

WORKING CONDITIONS

	Side 1	Side 2	
Max pressure	16	16	bar
Max temperature	165	165	°C
Min temperature	-10	-10	°C
Fluid group	2	2	

DESIGN DATA

Heat transfer area type	Corrugated Tube 8.0 mm
Heat transfer area	0.18 m ²
Tube side volume	0.6 l
Shell side volume	0.8 l
Weight	3.0 kg
Material group	SS 17-12-2,5

DIMENSIONS

A	122.00 mm
B	175.0 mm
C	390.0 mm
Dz	80.0 mm

CONNECTION TYPES

K1	Internal thread G 3/4"
K2	Internal thread G 1 1/2"
K3	Internal thread G 1 1/2"
K4	Internal thread G 3/4"

CONNECTIONS LOCATION
(Counter Flow)

K1 - side 1 inlet
K2 - side 2 outlet
K3 - side 2 inlet
K4 - side 1 outlet